

# Caymax Roof Mounting Component List

Item	Description	P/N	weight(g)
------	-------------	-----	-----------

<b>CV1 Pantile Anchor</b>	a=50mm, c=136mm, h=6mm	221104 CV1	862
---------------------------	------------------------	------------	-----

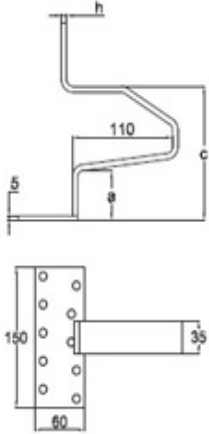

For hollow tile/flat roof tile/  
standard tile/double slot tile/roman tile/plain tile.  
Pre-assembled with aluminium clip to save manwork on site.  
Fixing onto the wood rafter with wood screw.  
Material: stainless steel 304  
Height-adjustable locating of the mounting rails

<b>CV1 Concrete Anchor</b>	a=40mm, c=105mm, h=5mm	221101-A CV	582
----------------------------	------------------------	-------------	-----

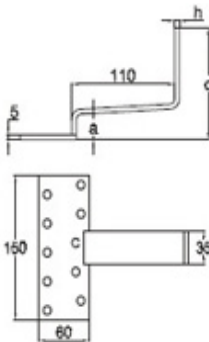

For hollow tile/flat roof tile/  
standard tile/double slot tile/roman tile/plain tile.  
Pre-assembled with aluminium clip to save manwork on site.  
Fixing onto the wood rafter with wood screw.  
Material: stainless steel 304  
Height-adjustable locating of the mounting rails

<b>CV1 Slate Anchor</b>	w=170mm, c=70mm, h=5mm	221106-A CV	331
-------------------------	------------------------	-------------	-----

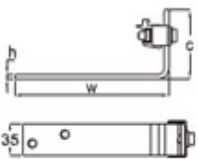

For slate tile.  
Pre-assembled with aluminium clip to save manwork on site.  
Fixing onto the wood rafter with wood screw.  
Material: stainless steel 304  
Height-adjustable locating of the mounting rails.

<b>CV1 Clay Anchor</b>	l=200mm, a=25mm, h=5mm	221102-A CV	460
------------------------	------------------------	-------------	-----

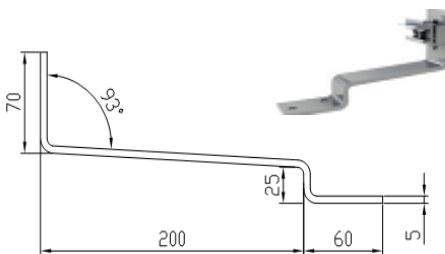

Used for narrow rafters  
Material: stainless steel 304  
Fixing with wood screw.

<b>CV1 Concrete Anchor</b>	a=50mm, c=105mm, h=5mm	221103-A CV	582
----------------------------	------------------------	-------------	-----

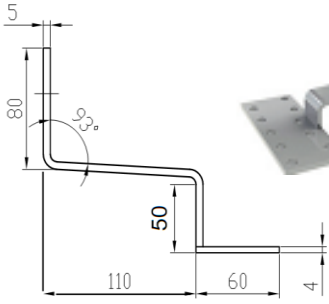

For hollow tile/flat roof tile/  
standard tile/double slot tile/roman tile/plain tile.  
Pre-assembled with aluminium clip to save manwork on site.  
Fixing onto the wood rafter with wood screw.  
Material: stainless steel 304

<b>CV1 Twist Anchor</b>	a=40mm, c=105mm, h=5mm	221105-A CV	585
-------------------------	------------------------	-------------	-----

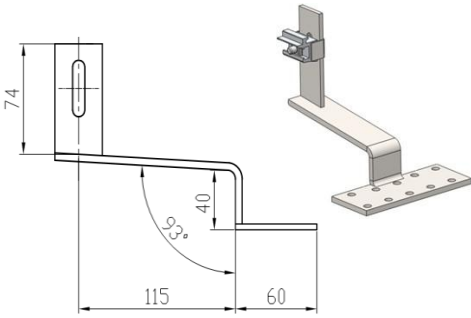

Landscape Panel installations  
For mounting on the side with vertical rails  
mounted base rails  
Material: stainless steel 304

**Hanger bolt CV1 series**



M12x300  
221202 CV1 300  
Corrugated and trapezoidal roof Hanger bolt & supporting bracket  
For use with a wooden sub-structure  
Material: stainless steel 304 & aluminium  
Pre-assembled, including a double threaded screw and aluminium clip.

<b>CV1 2.8m Rail</b>	Al 6063 T5, clear anodized, length 2.8m	110102 CV1	0.88kg/m
----------------------	---	------------	----------

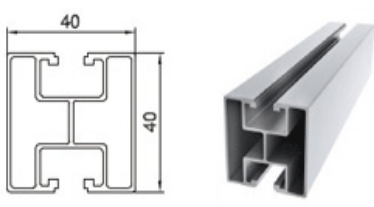

$I_x=6.24\text{cm}^4$   
The standard rail is 2.8m, length on request.

<b>CV1 Rail Connector</b>	Length=180mm	110202 CV1	72
---------------------------	--------------	------------	----







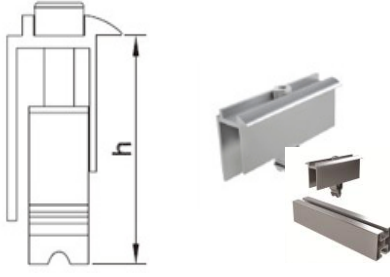
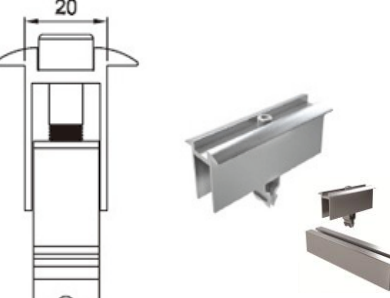

Material: Al 6063T5  
Used to connect Aluminium CV1 Rail  
Joining the rail with TWO flange bolts (421301 CV1)

<b>Flange bolt</b>	CV1 Rail Connector Nut   M8x12, stainless steel	421301 CV1	3
--------------------	---	------------	---



Material: SUS Stainless Steel  
M8x12

 <p>CV1 End clamp</p>	<p>Silver - 35mm  Black - 35mm  Silver - 50mm  Black - 50mm  Pre-assembled  Material: stainless steel &amp; aluminium  Incl. inner hex bolt and clip and square nut.</p>	<p>120125 CV1 103  120126 CV1 103  120131 CV1 110  120132 CV1 110</p>
 <p>CV1 Mid clamp</p>	<p>Silver - 35mm  Black - 35mm  Silver - 50mm  Black - 50mm  Pre-assembled.  Incl. inner hex bolt and clip and square nut.  Material: stainless steel &amp; aluminium  Incl. inner hex bolt and clip and square nut.</p>	<p>120225 CV1 92  120226 CV1 92  120231 CV1 98  120232 CV1 98</p>
 <p>Adaptor bracket TQ1 for trapezoidal roof</p>	<p>Apply to aluminium rails L40, S40, S60.  Incl. 4 tapping screws.  Made to the size of trapezoidal roof.  Material: Stainless steel, with adhesive EPDM rubber sealing pad.</p>	<p>3001 CV1 219</p>
 <p>Cross connection part X01</p>	<p>For rail's cross connection.  Including T-head bolt, M8x25, inner hex nut, Al alloy clamp.  Material: stainless steel and aluminium</p>	<p>3057 CV1 75</p>
 <p>Clippers For Roof Hook</p>	<p>Clippers Al-part for Roof hook VT12866</p>	<p>110202 CV1</p>
 <p>Wood screw</p>	<p>M8x100   galvanized</p>	<p>1090 CV1</p>
 <p>Expansion bolt</p>	<p>M10 x 110  Material: galvanized steel</p>	<p>1134 CV1</p>
 <p>Inner hexagon anti-theft bolt</p>	<p>Wrench for inner hexagon anti-theft bolt</p>	<p>427001 CV1</p>